

Agilent 5900 ICP-OES

The smart way to high productivity and low cost of ownership



Supercharge Your Lab's Business

The smart Agilent 5900 is designed to get the right answer faster than any other instrument, with the lowest cost per sample.

Measuring a sample per minute with reliable results and low argon consumption maximizes return on investment.



Minimize ownership costs

Reduce cost-per-sample

Argon use is a major contributor to the overall operating cost of an ICP-OES, with analysis time, argon gas flow rate, and purity requirements directly affecting it.

- The 5900 measures samples in half the time and has the lowest argon consumption per sample¹ of any ICP-OES instrument.
- An innovative, smaller Freeform optical design improves analytical performance and reduces gas purge times by half.
- Compatible with lower cost 99.99% purity Ar gas, further reducing gas costs by 50%.

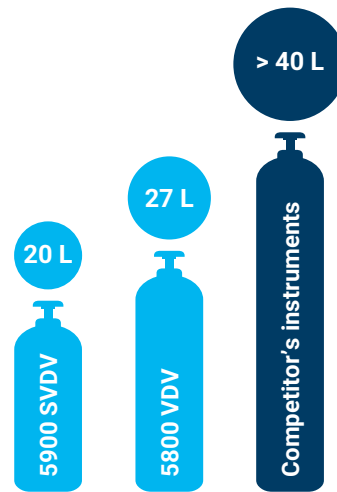

Dramatically reduce your argon consumption¹

The 5900 ICP-OES has the lowest argon consumption per sample of any ICP-OES instrument.

Minimize sample remeasurement and downtime

Reduce unexpected instrument downtime and remeasuring of samples by knowing more about your analysis. The Agilent 5900 has an ecosystem of embedded sensors and powerful processors, with smart algorithms and diagnostics. These smart features provide deep sample and operational insight, giving you greater confidence in the final result.

- The IntelliQuant software function quickly screens samples, determining the approximate concentration of up to 70 elements. It automatically identifies unexpected spectral interferences and recommends alternative wavelengths that are free from interference.
- Instrument uptime and performance are maximized with the use of smart health tracking diagnostics that monitor and alert the operator about instrument status.

Slash maintenance costs

Reduce unnecessary service call-outs and optimize maintenance schedules, based on actual instrument usage, rather than elapsed time.

- Up to a third of all service call-outs are linked to problems the operator could have solved themselves, with the right guidance
- Data-driven, usage-based maintenance schedules allow you to perform the right amount of maintenance. Usage-based maintenance ensures peak instrument performance and keeps service costs low.
- Reduce consumable replacement costs by ensuring sample introduction components and high-wear items are cleaned and replaced only when necessary.

¹ Argon consumption is calculated from argon flow rates multiplied by duration of flow. The analysis speed and gas consumption figures are compared to competitive systems, based on published application data.

Run More Samples at Lower Cost for Maximum Revenue Potential

Fast, accurate results in a single measurement

Conventional dual view ICP-OES systems require you to set up a series of sequential measurements by selecting which elements are measured in axial mode, and which are measured in radial mode. This takes time, making sample throughput slow.

The 5900 ICP-OES needs only a single measurement per sample—we call this Synchronous Vertical Dual View (SVDV). A unique optical component, the Dichroic Spectral Combiner (DSC), allows both the axial and radial views of the plasma to be captured in one reading. This delivers accurate results in the shortest possible time.

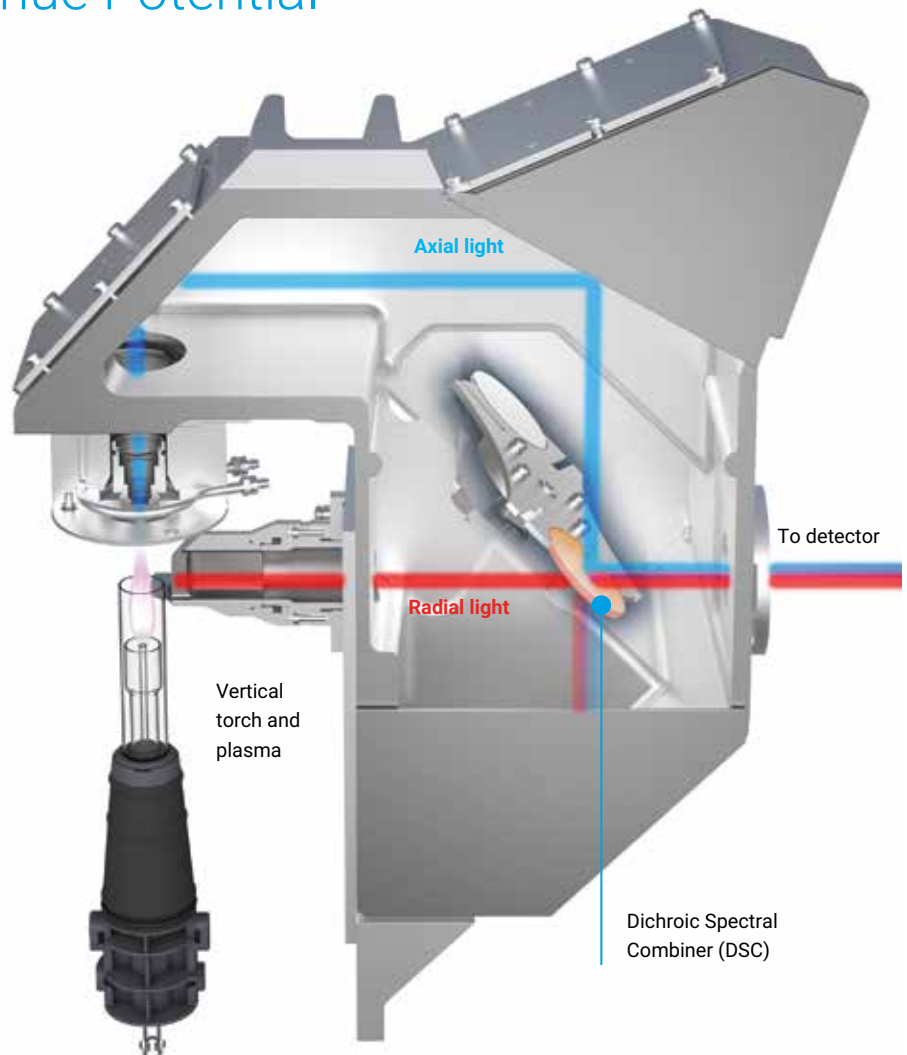

Fast analysis time = lower gas consumption

Many people fall victim to misleading claims that suggest flow rate directly correlates with gas consumption. While flow rate is an important factor, it can't be considered on its own. Analysis time is also critical. For example, if you halve your analysis time, you can reduce your argon use by nearly 40%, even if your argon flow rate is 20% higher.

This graph shows how the consumption of argon changes with flow rate and measurement time, for different sample batch sizes.

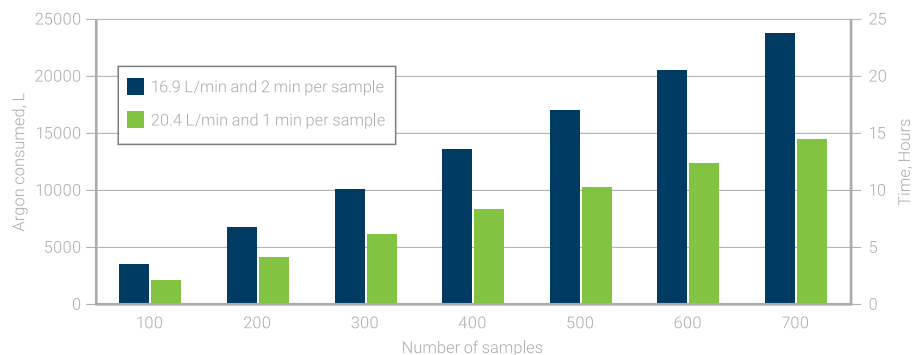

Reduce Downtime with a Smarter ICP-OES

Less downtime means more time to run samples and more revenue for your lab

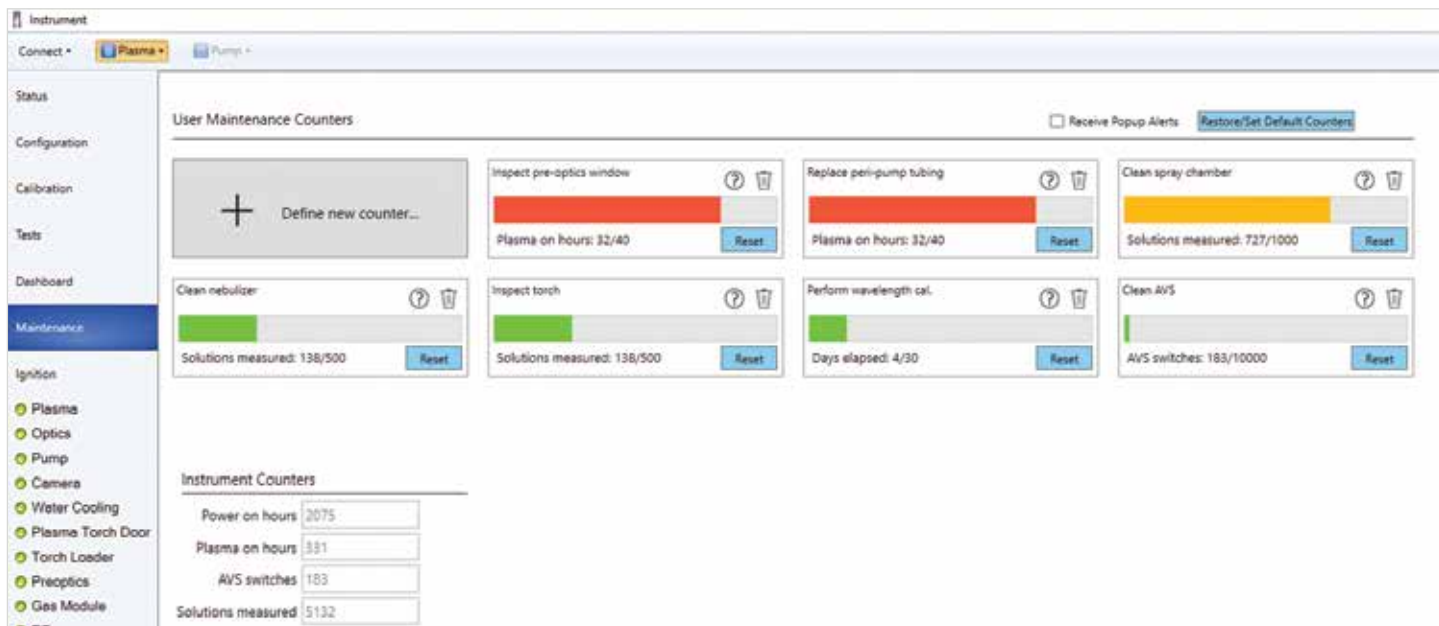

More uptime means more revenue

Maintain peak performance, maximize instrument uptime, and avoid problems before they occur. The smart diagnostics built into the 5900 monitor and alert you when maintenance is required. Traffic light color-coding of the counters visually shows which maintenance activities should be done immediately, and which can wait.

This early maintenance feedback system reduces downtime and repair costs by scheduling routine maintenance of components based on actual usage, rather than at set time intervals.

The Neb Alert function provides real-time warning on unpredictable events such as nebulizer leaks and blockages. These alerts enable quick response and less wasted time when analyzing samples with high solids.

Even peripherals such as autosamplers and other accessories can be monitored. Alerts are issued when smart sensor thresholds are exceeded.

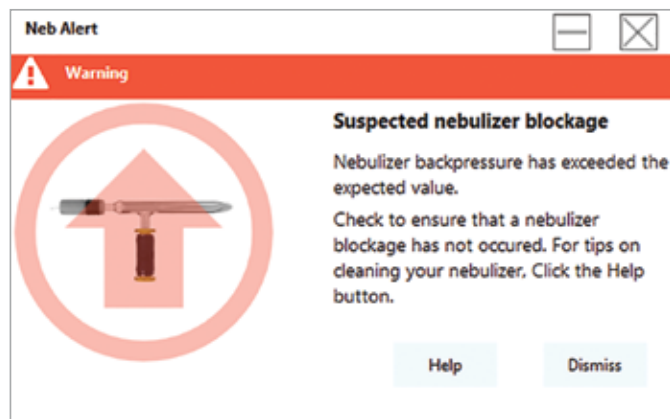

Learn More About Your Samples

Get insight into what's in your sample and how to best measure it

IntelliQuant puts the power of an experienced analyst inside your instrument—and only Agilent has it

IntelliQuant captures data from the entire wavelength range as each sample is measured, then uses this broader view to calculate the approximate concentration of up to 70 elements in a sample. By collecting more than just the data at the wavelengths nominated, IntelliQuant sees spectral interferences and provides you with recommendations to ensure you get the right answers every time.

Running unknown or atypical samples? Put IntelliQuant to work, and ease your method development, troubleshooting, and sample screening challenges.

It's like having QC on every sample

If your results are too high, it could be due to a spectral interference from another element. Results that are too low could be due to chemistry problems. IntelliQuant uses data analytics to automatically identify spectral overlaps that can lead to false-positive results, and recommends the emission wavelength that will give the most accurate result.

The example on the right shows the measurement of cadmium at 228.802 nm. The measured emission (blue line) has been erroneously increased by the presence of an emission from arsenic (red line). IntelliQuant will flag this wavelength as being problematic using a star ranking feature (shown below) to make it easy for the user to select the right wavelength to report on.

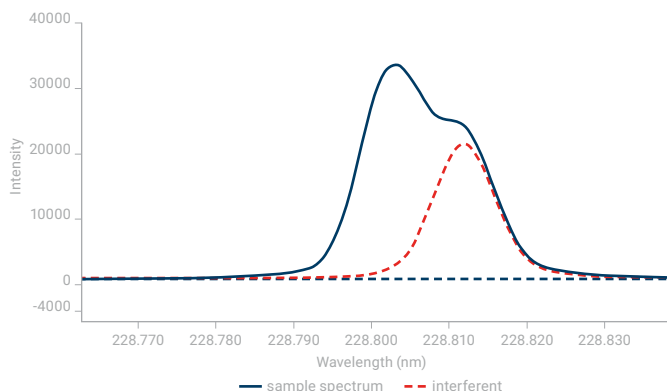

Wavelength (nm)	Star Ranking
214.439	*****
226.502	***
228.802	* ?
361.051	*
326.105	**
508.582	*

Analyte: Cd(228.802)
Confidence: moderate
Interference: As(228.812)
Confidence: strong

IntelliQuant Star ranking output for Cd. A five-star ranking with green check mark indicates Cd 214 wavelength to be the best. The red question mark indicates there is an issue on Cd 228, and the pop-up tip indicates the Cd 228 result has only moderate confidence as it has a strong arsenic interference.

Fast sample screening

IntelliQuant Screening can be used to determine the approximate concentration of up to 70 elements in a sample within seconds. Ideal for:

- Method development assistance for unknown samples
- Trend analysis for batches of samples measured routinely, such as soils, engine oils, or plating baths

Results can be presented in a range of smart views for users to quickly review the constituents of a sample (pie chart view shown below).

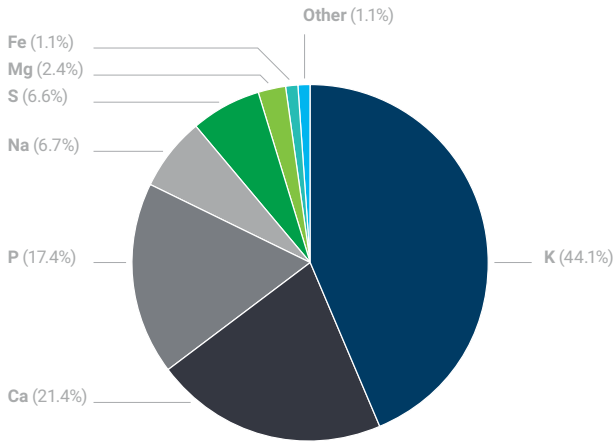

Flagging outlying results

An outlier alert highlights results that exceed a nominated range or don't pass a test. The outlier alert system can monitor a range of parameters, from %RSD through to failed QC tests, and can be configured to your requirements.

Results can be filtered to show only the samples that have failed. Filtering makes it easy to see which results need to be reviewed.

The image below shows the flagging of outlier results on the sample results screen. On the right is shown a filter applied to display only the outliers that are in need of review.

Rank	Batch	Solution Label	Outlier Summary	Ca	Cd	Cl	Cu	Fe	II	Li	Si	Mg
22	ORCSA-45a-2		0.619 conc	1.2646	1.1883	19.6747	14.8838	3549.8498	57.8998	0.4167	0.1526	7
23	SFW 2751-1		238.738 conc	0.2281	0.1247	3.7989	11.3385	429.8713	93.9258	0.2827	0.1407	187
24	SFW 2751-3		207.218 conc	0.2323	0.1270	3.8198	11.8284	434.5738	97.1176	0.2894	0.1446	189
25	SFW 2752-1	A	127.385 conc	5.9177	4.4898	2.3081	55.5204	5085.2510	71.4071	1.2248	0.1586	85
26	SFW 2752-2		107.075 conc	1.8422	1.8283	2.1963	21.4172	5474.8289	87.6586	1.5004	0.1570	52
21	ORCSA-45a-1		313.368 conc	1.4282	1.2215	20.2521	15.3607	3395.9574	61.8904	0.2947	0.1407	8
22	ORCSA-45a-2		768.491 conc	1.4842	1.1896	20.8833	16.1864	3419.8162	59.4210	0.4168	0.1588	7
23	SFW 2751-1		408.871 conc	0.2293	0.1244	3.8020	11.4742	434.8713	95.1176	0.2911	0.1410	113
24	SFW 2751-2		975.751 conc	0.2416	0.1266	3.8245	12.2483	565.3115	100.6666	0.4072	0.1410	152
25	SFW 2752-1	A	107.075 conc	1.8941	1.4752	2.2826	19.8837	6422.7162	71.1888	1.0181	0.1284	95
26	SFW 2752-2		107.075 conc	1.8689	1.4463	2.2234	15.5604	5436.4548	66.9090	1.1341	0.1276	81
21	ORCSA-45a-1		313.368 conc	1.4973	1.2348	20.8513	16.3819	3447.8621	62.1334	0.4183	0.1577	4
22	ORCSA-45a-2		768.491 conc	1.4998	1.2027	20.1388	15.2630	3419.2365	59.4497	0.4168	0.1285	7
23	SFW 2751-1		238.738 conc	0.2294	0.1267	3.8933	11.8111	501.2126	98.6493	0.2908	0.1374	113

Spot sample preparation mistakes

Did someone forget to put HCl in during the digestion process? By running your eye over the IntelliQuant results, shown as a heat map below, you can quickly identify whether Cl is present and know that the digestion was done correctly. The same approach can be used for most acids used for sample digestion.



Elements shaded red are in high concentration, orange are in mid-range concentration, and those in yellow are in low concentration. Unshaded elements are not at detectable levels in the sample. In this case, Cl is missing, indicating that HCl was not used during sample preparation.

Rank	Batch	Solution Label	Outlier Summary	Ca	Cd	Cl	Cu	Fe	II	Li	Si	Mg
22	ORCSA-45a-2		0.619 conc	1.2646	1.1883	19.6747	14.8838	3549.8498	57.8998	0.4167	0.1526	7
23	SFW 2751-1		238.738 conc	0.2281	0.1247	3.7989	11.3385	429.8713	93.9258	0.2827	0.1407	187
24	SFW 2751-3		207.218 conc	0.2323	0.1270	3.8198	11.8284	434.5738	97.1176	0.2894	0.1446	189
25	SFW 2752-1	A	127.385 conc	5.9177	4.4898	2.3081	55.5204	5085.2510	71.4071	1.2248	0.1586	85
26	SFW 2752-2		107.075 conc	1.8422	1.8283	2.1963	21.4172	5474.8289	87.6586	1.5004	0.1570	52
21	ORCSA-45a-1		313.368 conc	1.4282	1.2215	20.2521	15.3607	3395.9574	61.8904	0.2947	0.1407	8
22	ORCSA-45a-2		768.491 conc	1.4842	1.1896	20.8833	16.1864	3419.8162	59.4210	0.4168	0.1588	7
23	SFW 2751-1		408.871 conc	0.2293	0.1244	3.8020	11.4742	434.8713	95.1176	0.2911	0.1410	113
24	SFW 2751-2		975.751 conc	0.2416	0.1266	3.8245	12.2483	565.3115	100.6666	0.4072	0.1410	152
25	SFW 2752-1	A	107.075 conc	1.8941	1.4752	2.2826	19.8837	6422.7162	71.1888	1.0181	0.1284	95
26	SFW 2752-2		107.075 conc	1.8689	1.4463	2.2234	15.5604	5436.4548	66.9090	1.1341	0.1276	81
21	ORCSA-45a-1		313.368 conc	1.4973	1.2348	20.8513	16.3819	3447.8621	62.1334	0.4183	0.1577	4
22	ORCSA-45a-2		768.491 conc	1.4998	1.2027	20.1388	15.2630	3419.2365	59.4497	0.4168	0.1285	7
23	SFW 2751-1		238.738 conc	0.2294	0.1267	3.8933	11.8111	501.2126	98.6493	0.2908	0.1374	113

Future-Proof your Lab with the ICP Technology Leader

Meet the Agilent 5900 ICP-OES

High performance with lower argon cost

Innovative Freeform optics deliver low detection limits and high resolution, even when using 99.99% purity bottled argon. The optical layout is compact, so is quick to purge, reducing the wait time before samples can be measured.

Resilient vertical torch

The vertically oriented torch means less cleaning, less downtime and fewer replacement torches. A torch loader mechanism automatically aligns the torch and connects gases for fast startup and reproducible performance.

Built-in performance tests

How do you know an ICP-OES is operating as it should? The performance tests built into the 5900 quickly confirm that everything is OK, before you start measuring samples.

Corrosion resistant, dust resistant

The 5900 is made from corrosion-resistant material and uses internal positive pressures and optimized airflows to keep out acid vapors. An easy-to-remove air filter protects your instrument in dusty environments and an air flow monitor alerts you when the filter needs replacing.

Small footprint

As the smallest ICP-OES available, the 5900 saves valuable bench space. Connections for power, gas, cooling, water, and communications are easily accessed—from the side rather than the rear.

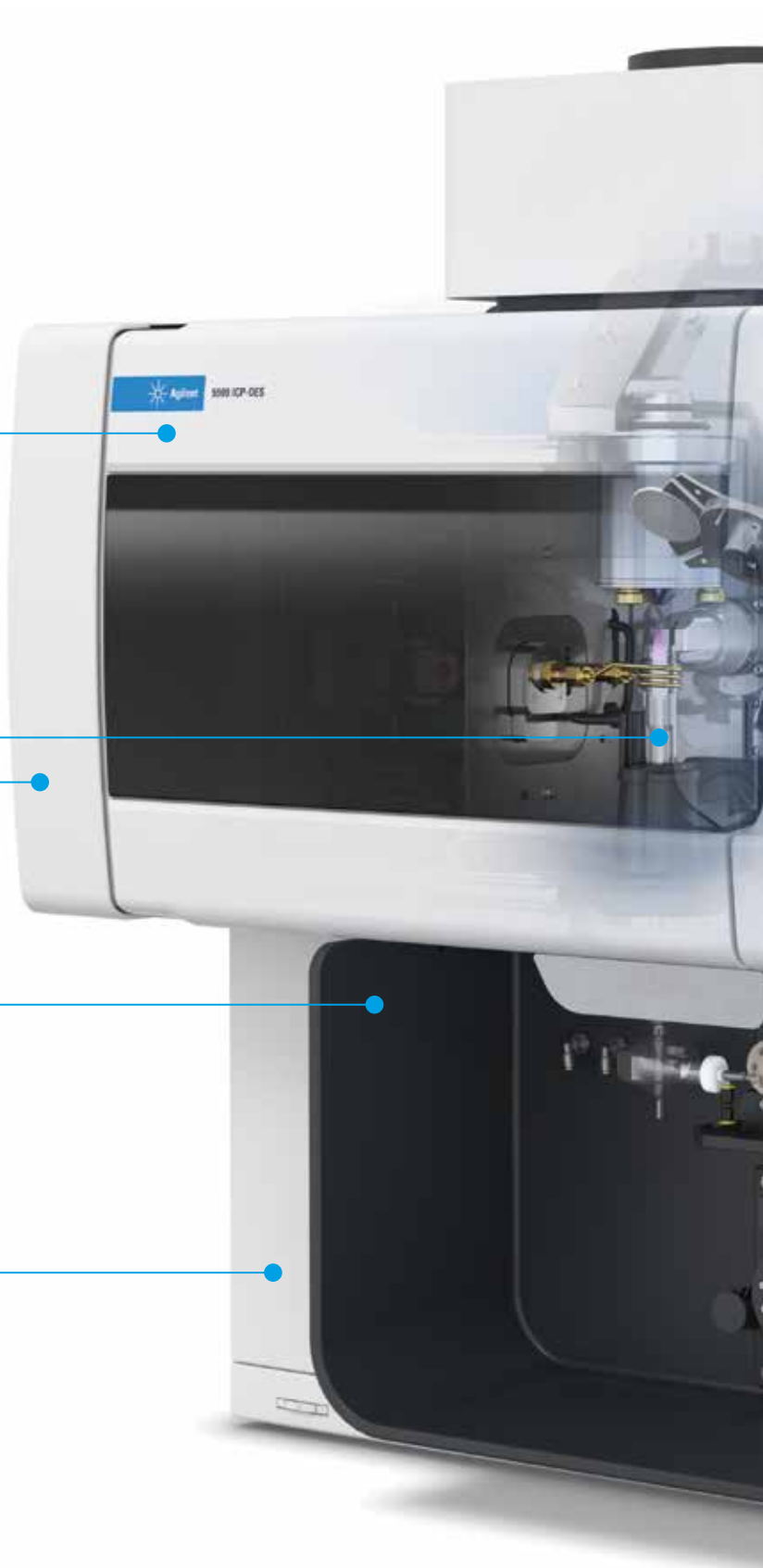



The Agilent 5900 Synchronous Vertical Dual View (SVDV) ICP-OES

Fast, accurate results in a single measurement

A specialized optical component, the Dichroic Spectral Combiner, enables synchronous measurement of both views (axial and radial) of the plasma. Only one reading is needed per sample, delivering accurate results faster than any other ICP-OES.

High-speed, intelligent detector

A unique detection system delivers fast, simultaneous measurement over the full wavelength range, irrespective of concentration or signal strength. Detector advancements take smart software features to the next level – guiding you to achieve the right answer the first time.

Smart algorithms

Take the guesswork out of method development and automate troubleshooting with built-in smart algorithms:

- **Fitted background correction (FBC)** automatically provides accurate background correction.
- **Fast Automated Curve-fitting Technique (FACT)** or **InterElement Correction (IEC)** technique for spectral interference correction.
- **IntelliQuant** allows rapid identification of all elements in a sample and their relative concentration. Ideal for method development, troubleshooting and sample screening.
- **Intelligent Rinse** maximizes throughput by automatically optimizing the rinse time between samples whilst preserving the accuracy of results.

Integrated switching valve

The Advanced Valve System (AVS) speeds up analysis, improves analytical precision, reduces cost per sample, and helps reduce blockages and downtime by providing more efficient introduction and washout of samples.

Self-diagnosis and health tracking

Self-diagnosing electronics monitor instrument status, allowing rapid identification of component health issues. Sensors and counters alert the analyst when maintenance is required.

Smart Utility Health Tracking

Instrument monitoring to keep operations running smoothly

Gas supply health tracking

The 5900 monitors the spectral emission from argon for every sample. If the argon emission monitor shows that the emission is fluctuating, it could indicate a partial torch blockage or partial plasma quenching. The problem can be investigated, and sample results checked.

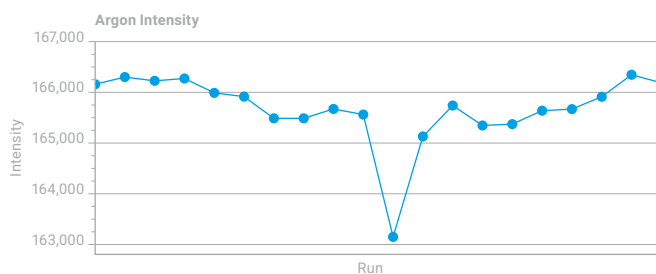

Plasma ignition health

On-screen tips provide reminders to prevent common causes of plasma ignition failure.

In the case of plasma ignition failure, onboard smart tools provide advice on remedies.

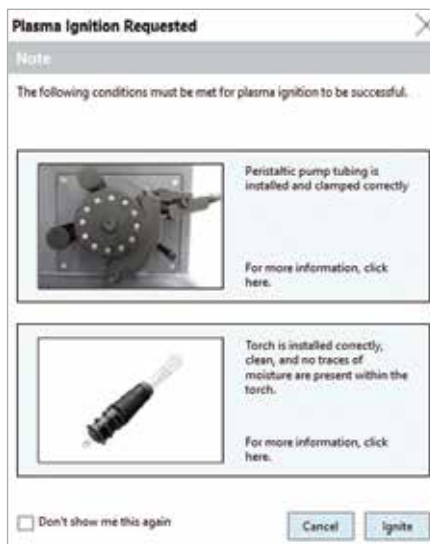



Accessories

Options to further enhance your workflow



SPS 4 Autosampler

This flexible-configuration automatic sampler holds up to 360 samples. It is robust, easy to use, and ideal for unattended elemental analysis.



IsoMist

The IsoMist is a temperature-controlled spray chamber. It can be adjusted between -10 and $+60$ °C. Lowering the temperature of the spray chamber improves the long-term stability of volatile organic solvent analysis.



Application-specific sample introduction options

A range of optimized torches and sample introduction kits is available for:

- Organic solvents
- High salt or high matrix samples
- Samples containing hydrofluoric acid (HF)

You can minimize costs with demountable torches, designed for easy maintenance, fast changeover, and economical operation.



Multimode Sample Introduction System (MSIS)

MSIS provides simultaneous measurement of hydride and non-hydride elements including As, Se, and Hg to sub-ppb levels. Simultaneous measurement eliminates changeover and allows routine and hydride elements to be determined simultaneously using the same setup.

Agilent CrossLab: Real insight, real outcomes

CrossLab goes beyond instrumentation to bring you services, consumables, and lab-wide resource management. So your lab can improve efficiency, optimize operations, increase instrument uptime, develop user skill, and more.



Learn more:

www.agilent.com/chem/5900icpoes

Buy online:

www.agilent.com/chem/store

Get answers to your technical questions and access resources in the Agilent Community:

community.agilent.com

U.S. and Canada

1-800-227-9770

agilent_inquiries@agilent.com

Europe

info_agilent@agilent.com

Asia Pacific

inquiry_lsca@agilent.com

This information is subject to change without notice.

© Agilent Technologies, Inc. 2019
Published in the USA, October 28, 2019
5994-1277EN

